

Rotating Telehandlers

ROT070.24



 **MERLO**



PERFORMANCE AND FEATURES	ROTO70.24S	ROTO70.24SPLUS	
Performance			
Total unladen weight (kg)	19500	20200	
Maximum capacity (kg)	7000	7000	
Lifting height (m)	24,2	24,2	
Maximum reach (m)	20,5	20,5	
Maximum operating height (m)	7,4	7,4	
Maximum operating reach (m)	5,9	5,9	
Capacity at maximum height (kg)	3000	3000	
Capacity at maximum reach (kg)	900	900	
Lateral boom movement (mm)	-	-	
Tilting correction (%)	± 12; ± 4	± 12; ± 4	
Boom sections	4	4	
PowerTrain			
Turbo motor	FPT NEF45	FPT NEF45	
Displacement/cylinders	4500/4	4500/4	
Engine Power (kW/HP)	125/170	125/170	
Anti-pollution technology	STAGE V, DOC + DPF+ SCR	STAGE V, DOC + DPF+ SCR	
Reversible fan	-	-	
Maximum speed (km/h)	40	40	
Fuel tank (l)	150	150	
AdBlue tank (l)	43	43	
Hydrostatic transmission	● - 2V	● - 2V	
EPD	●	●	
Auto-revving joystick	●	●	
Axles - Reducers	Axial, Epicyclic	Axial, Epicyclic	
Machine brakes	Dry discs	Dry discs	
Automatic parking brake	●	●	
Hydraulic			
Hydraulic pump	LS + FS	2 - LS + FS	
Flow rate/pressure (l/min - bar)	138 - 250	138+100 - 250/230	
Hydraulic tank	120	120	
Hydraulic outlet at the top of the boom	●	●	
Rear hydraulic outlets	-	-	
Cab			
Cab configuration	Premium	Premium	
ASCS Adaptive Stability Control System	Full	Full	
FOPS LIV II cab	●	●	
ROPS cab	●	●	
Cab commands	Electronic joystick control	Electronic joystick control	
Tilting Cab	-	●	
Reverse shuttle	Dual Reverse	Dual Reverse	
Configuration			
Cab suspension	-	-	
Boom suspension	○	○	
Suspension on axles	●	●	
Work headlights on cab	○ - Led	○ - Led	
Sun blind	●	●	
Tac-lock	●	●	
Provision for a platform	●	●	
Two floating forks	●	●	
Inching-Control	-	-	
Four-wheel drive	●	●	
Four-wheel steering	●	●	
Three steering modes	●	●	
Standard tyres	445/65-R22.5	445/65-R22.5	
Optional tyres	-	-	
Stabilisers	Multiposition	Multiposition	
Turret rotation	continuous	continuous	
Type approval as an agricultural tractor	-	-	
Approval with PNEUMATIC braking	-	-	
Approval with HYDRAULIC braking	-	-	
PTO	-	-	
3-point linkage	-	-	

- Not Available
● Standard
○ Optional

Load charts

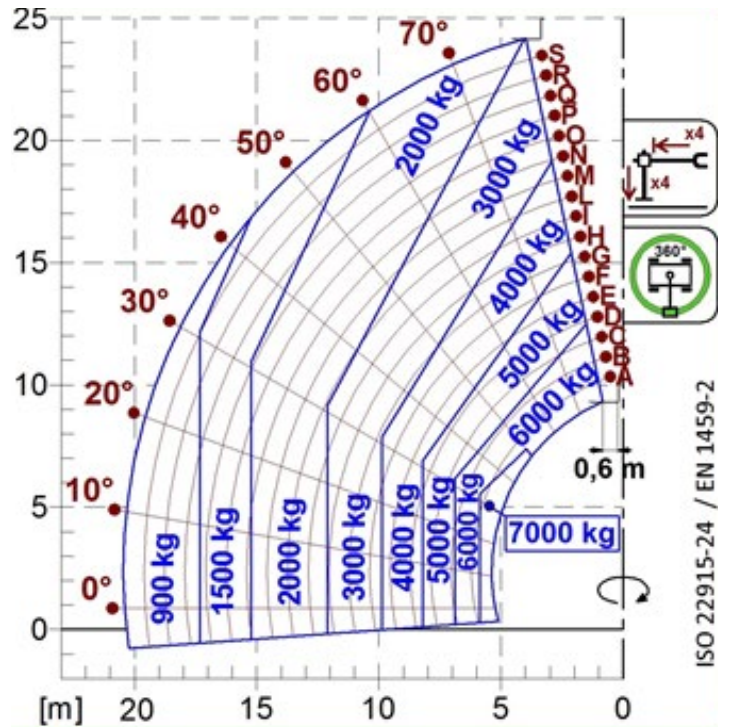
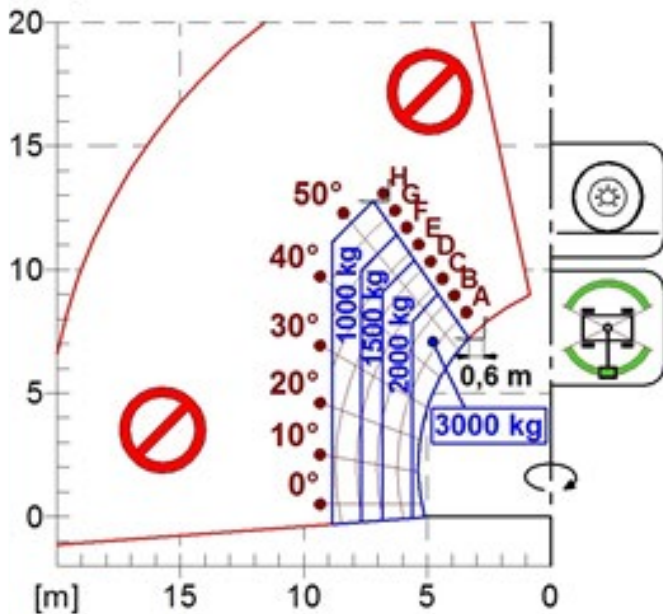
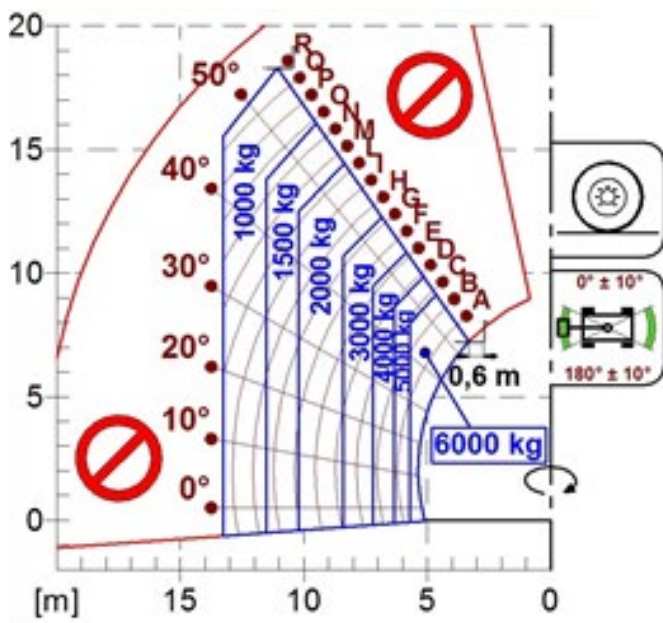

ROTO70.24

Dimensions



	ROTO 70.24		
A (mm)	7545		
C (mm)	3200		
E (mm)	5620		
F (mm)	290		
H (mm)	2490		
L (mm)	5260		
M (mm)	1010		
N (mm)	3170		
P (mm)	3160		
R (mm)	4500		
S (mm)	6770		
Z (mm)	850		

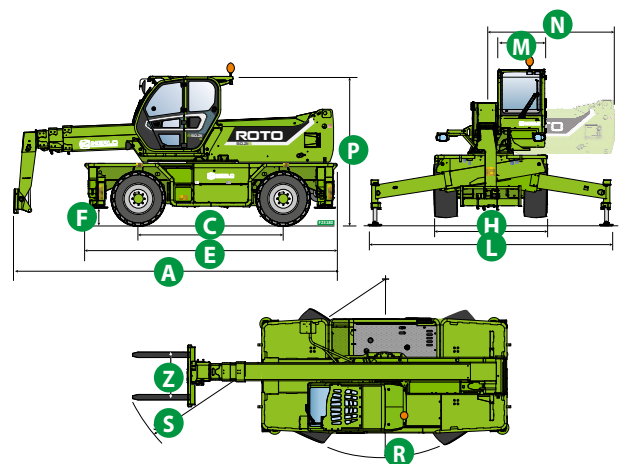

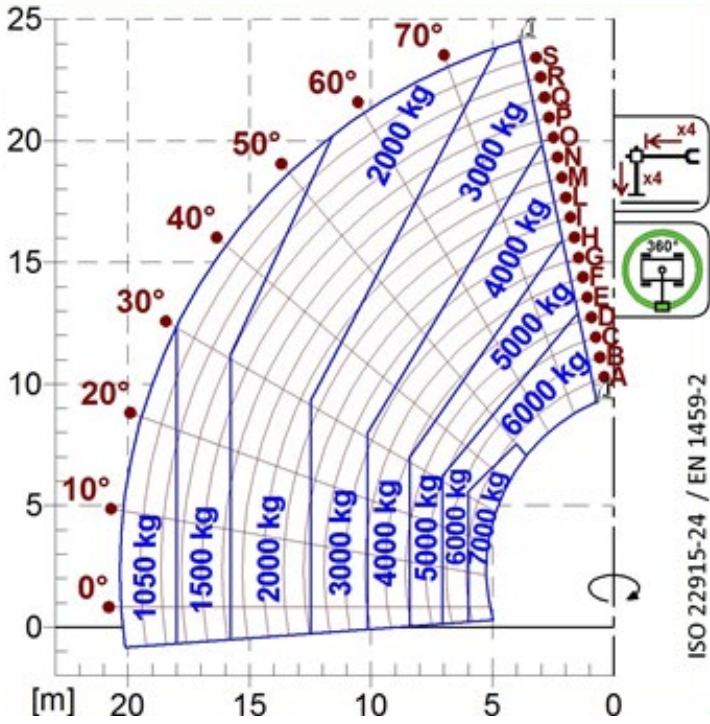

A1001

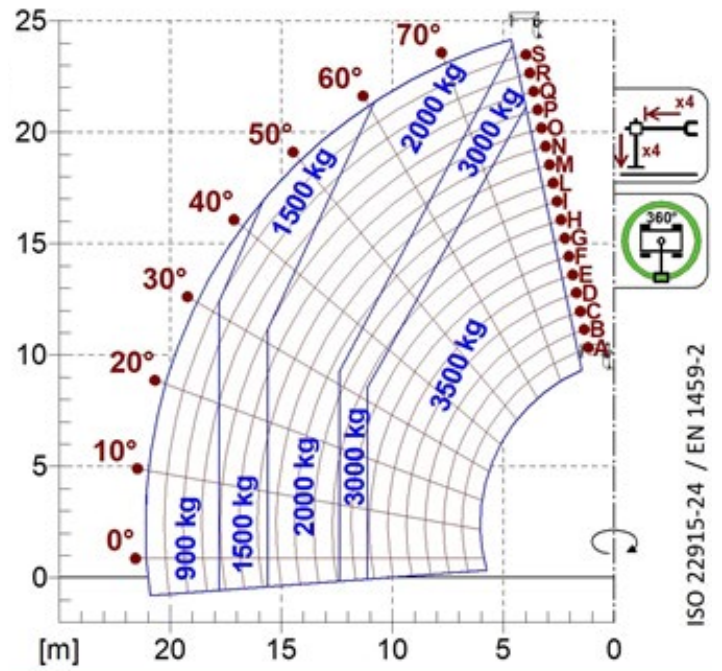

A1119B

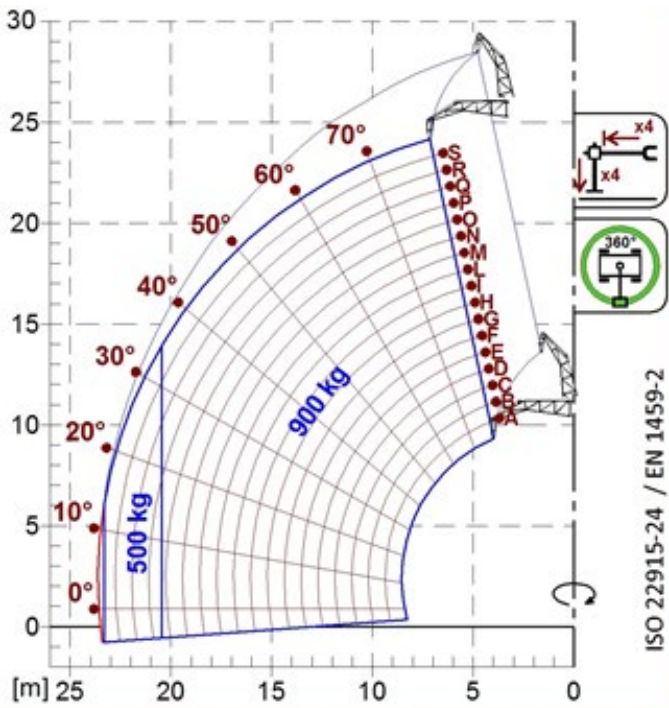

A1220B
A1320B

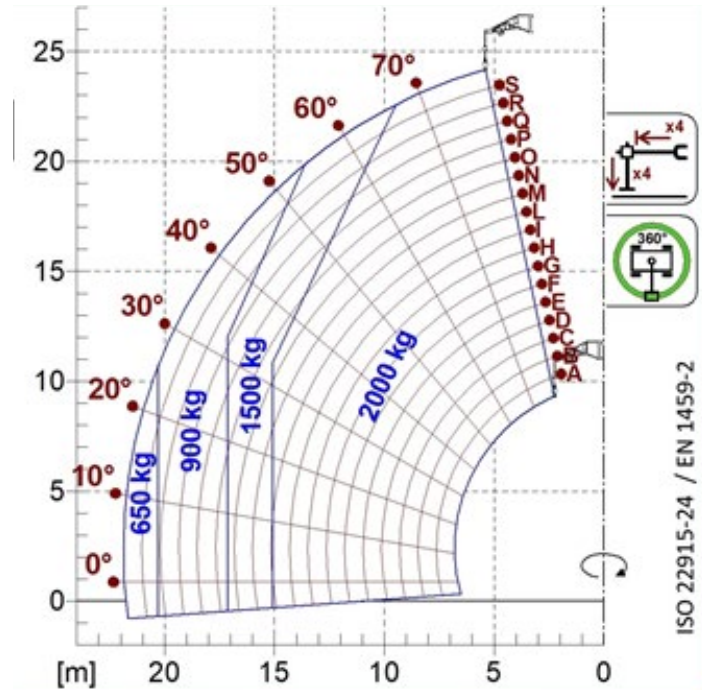

A1321B

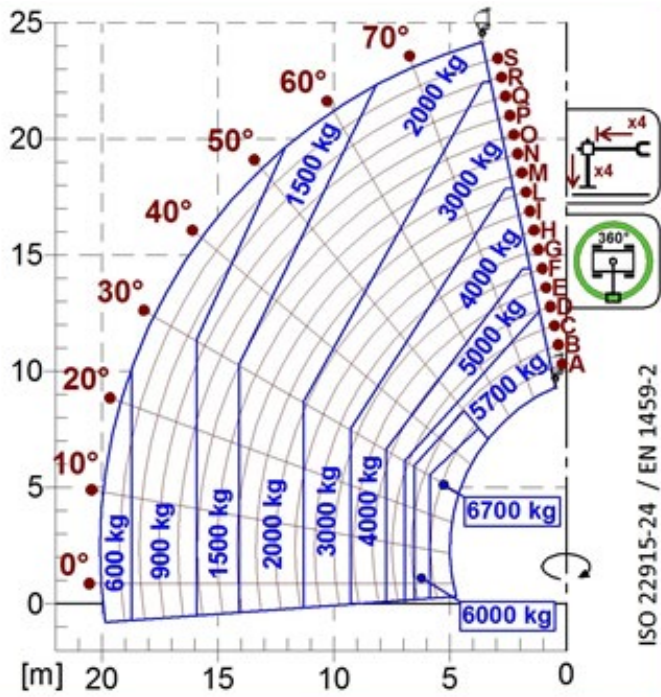

A2768
A2769

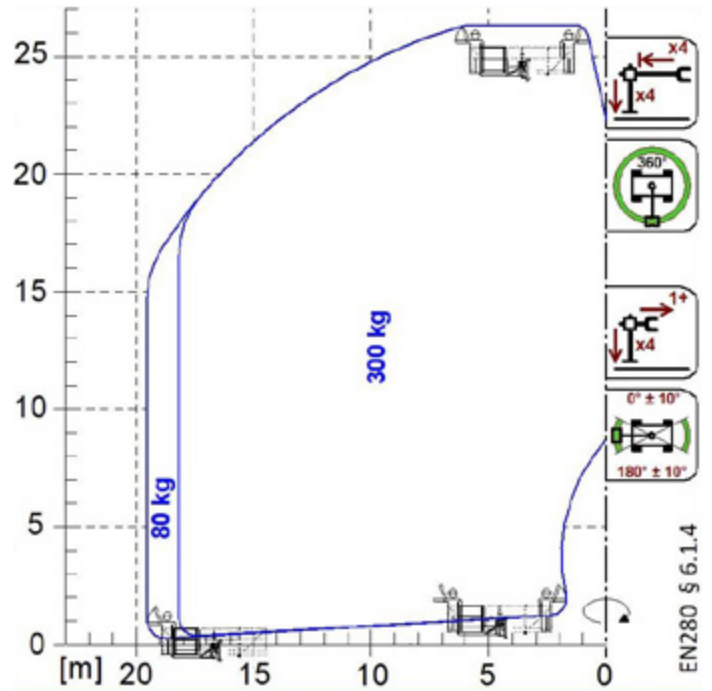

A1827A
A1839A

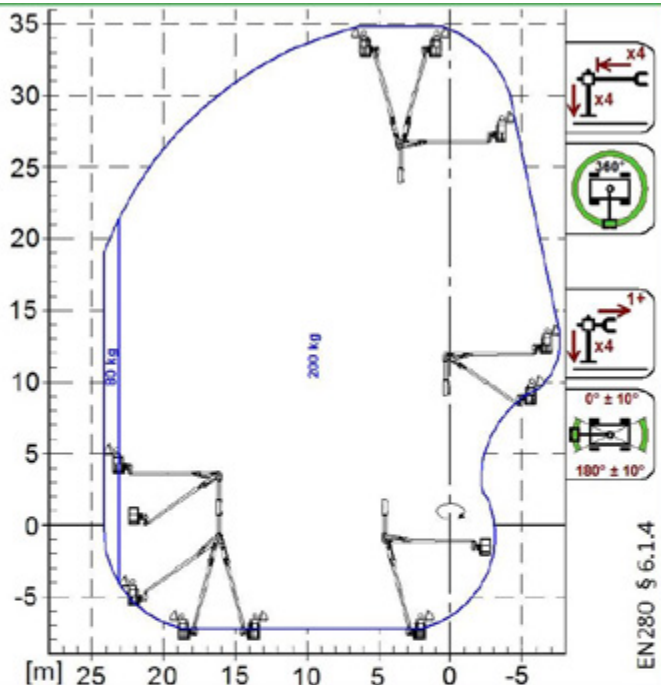

A1873A

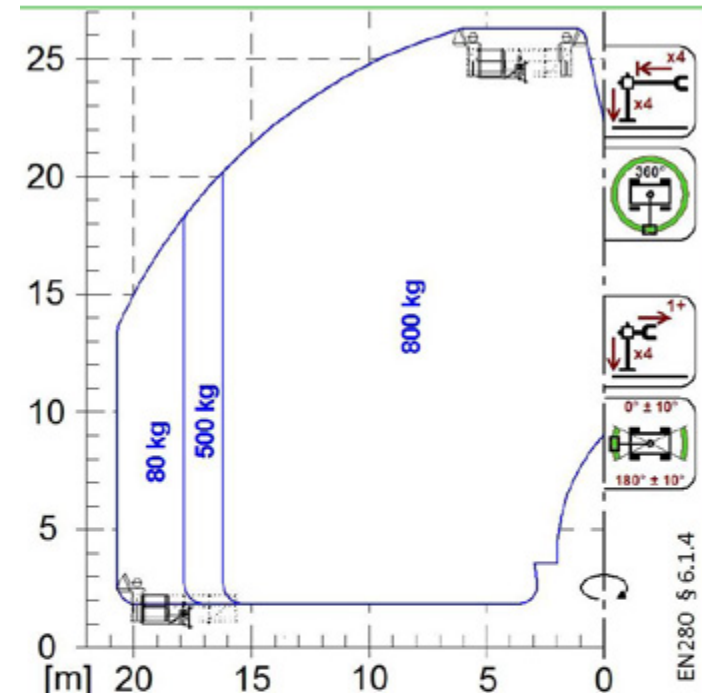

A1831A

Your Merlo dealer



MERLO S.P.A.

Via Nazionale, 9

12010 S. Defendente di Cervasca, (Cuneo) Italia

Tel. +39 0171 614111

Fax +39 0171 684101

info@merlo.com

www.merlo.com

